

Installation Instructions

Century® Mate

20' and 30' Wide Systems



Please read all of the installation instructions before the installation or removal of this product.



7701 Highway 41 N
Evansville, IN 47725
Phone: 812-867-2421
Fax: 812-867-1429
1-800-544-4445
email: tents@anchorinc.com
www.anchorinc.com

CENTURY MATE PARTS LIST

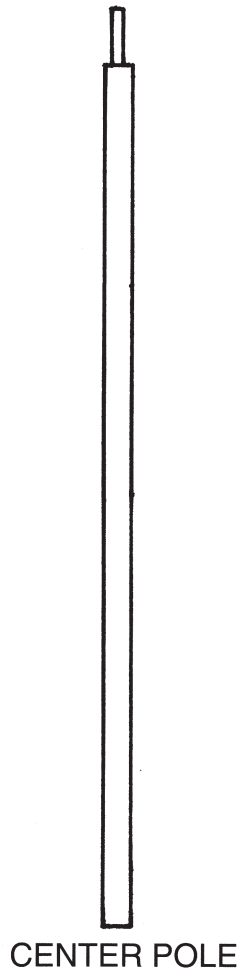
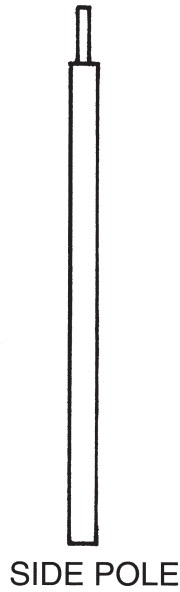

MANPOWER REQUIRED

Two installers should be able to assemble a Century Mate in approximately thirty minutes.

TOOLS REQUIRED

Sledge Hammers

INSPECT SITE

CAUTION:

Consult local utility company, prior to installation.

Prior to assembly be sure to look around area for obstacles, pipes, wires, etc.

LAYOUT & CHECK

Use parts list for a quick identification and check list for proper quantities.

PARTS	TENT SIZE					
	20 x 20	20 x 30	20 x 40	30 x 30	30 x 45	30 x 60
SIDE POLE	8	10	12	16	20	24
CENTER POLE	1	2	2	1	2	3
STAKES	12	14	16	20	24	28
BAG WITH TOP	1	1	1	1	1	1

1) LAYOUT AT SITE

20' x 30' tent used as example. Spread drop cloths and unroll tent at exact location of desired finished assembly. Any sharp objects which must remain on site under the tent must be padded and taped.

Lay side poles straight out from each pole hole in tent.

Check guys to be sure they allow plenty of slack for raising tent and enough for ratcheting after tent is properly set up. (approximately 2' of slack)

Run stakes through ring on guy web. Drive stakes 1' in from the end of each pole

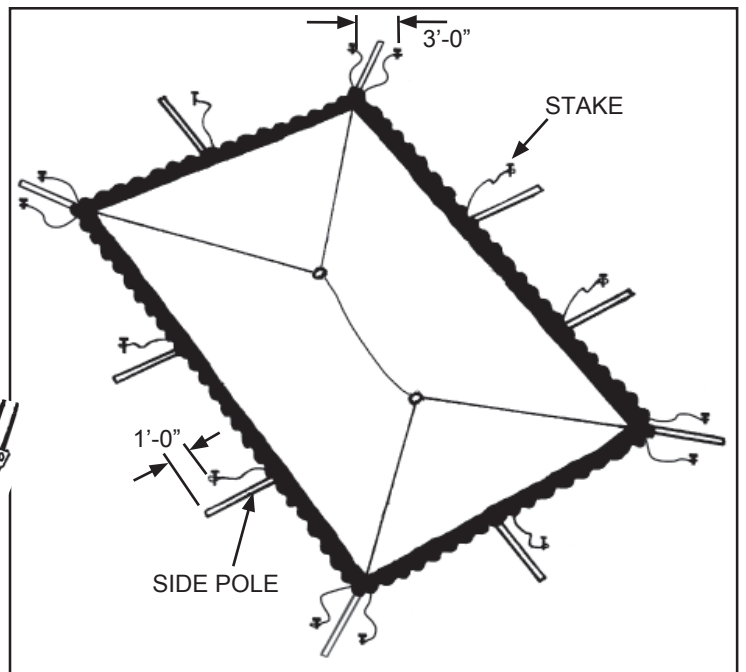
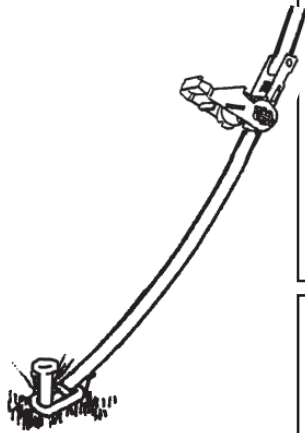

2) RAISE SIDE POLES

Start at opposite corners. Insert side poles into pole holes and raise so that bottom of poles slant toward center of tent. Tie off jump ropes to poles.

Continue with other two corners and then sides.

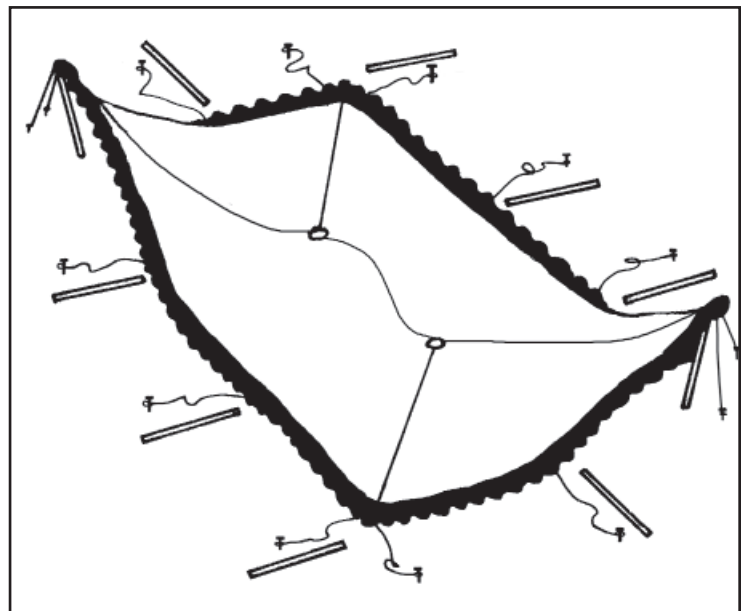

3) RAISE CENTER POLE

Insert Center pole into Center Pole Hole in Fabric.

Raise to upright position and tie off jump rope to pole.

CAUTION: At this point, it is required to properly anchor bases of all center poles to prevent movement.

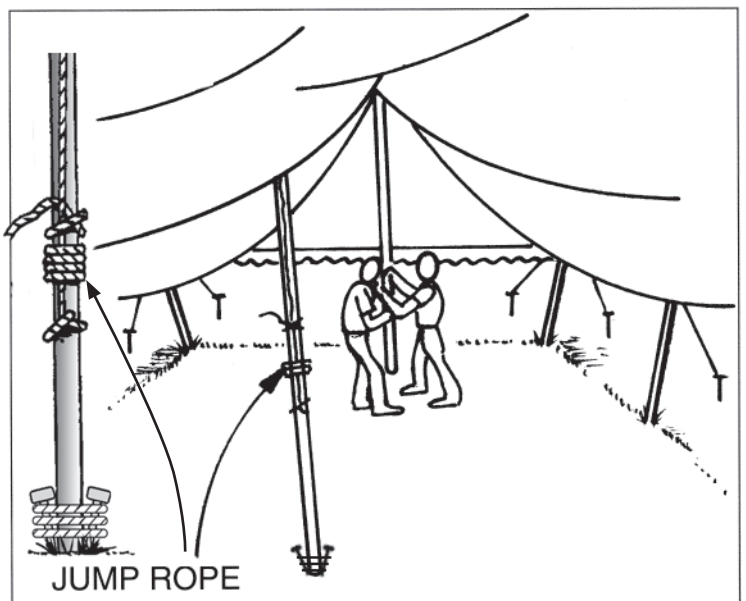

4) SIDE POLE ADJUSTMENT

Tighten guy webs and then set side poles to upright position. Adjust pole positions and guy line tension to properly pull out tent.

Protective covers are recommended for all stakes.

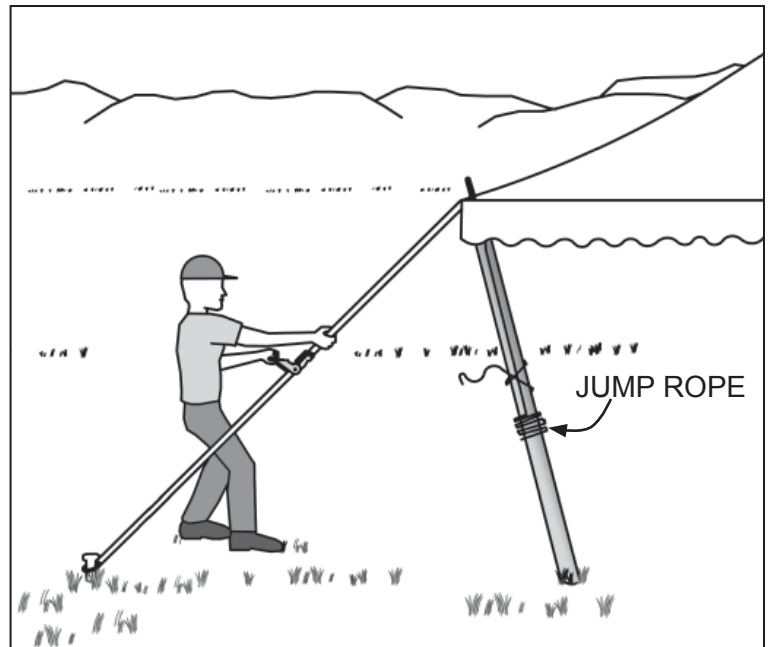

5) TAKE DOWN

Loosen all guy webs.

Spread drop cloths.

Reverse steps 1 through 4 for disassembly.

IMPORTANT:

Check guy webs periodically for tightness and maintaining good condition. Stakes provided are for average soil conditions. Sandy soil or asphalt may require additional staking. Proper installation suitable to site conditions is the responsibility of the installer. Store tent in a cool, dry area. Never store while wet or damp.



PHONE NUMBER
812 · 867 · 2421

FAX NUMBER
812 · 867 · 0547

Anchor products are of superior design and operate best within the parameters of these instructions. It is imperative that the instructions be carefully read and **COMPLETELY FOLLOWED**. Please read installation instructions before the installation or removal of this product. Installation instructions are available online at www.anchorinc.com or by calling 1-800-544-4445.

CAUTION:

1. For each installation, the installer is solely responsible for evaluating the site and the proper securing method determined. Some soils require different staking or securing than that provided with the tent. Due to this variety of soil conditions, these are the manufacturer's suggested sequence of installation procedures. Anchor's responsibility is limited to the manufacture of the tent parts and materials. We are not responsible for methods that installers may choose to erect and secure the tent to the ground.
2. The number of stakes suggested in the installation instructions do not necessarily meet all or any relevant codes on the site of the tent installation. The number of stakes suggested **will, in many cases, keep the tent erected**, however, due to various soil conditions; these stakes will be insufficient **to keep the tent secure in high winds**. It is the tent installer's responsibility, not the manufacturer, to determine the appropriate number of stakes to meet the necessary wind loads on the site. Regardless of the number of stakes we suggest, we make no representation or warranty as to whether this specific number of stakes will meet the local tent code. Anchor does not, nor can it make any suggestions, representation, or warranties about the adequate staking required at each specific installation site. Staking information provided in the installation instructions **is not a suggestion about what is necessary to meet a site-specific load**.

For additional important information, consult: "The IFAI Procedural Handbook For the Safe Installation and Maintenance of Tentage" and the IFAI Pocket Guide "Pullout Capacity of Tent Stakes", both available from the IFAI Tent Rental Division or on our website.

3. Inasmuch as the weather is unpredictable, good judgment and common sense must be incorporated within installation guidelines. It is the responsibility of the tent installer/maintainer to determine the severity of the weather, proper time and method of installation and/or erection and disassembly. **Note: We recommend that snow and ice be removed from the tent surface as soon as possible because accumulation will damage the tent or fabric structure. Please consult with our Engineering Department about the maximum loads for each product.**

This product has been manufactured for use as a temporary structure. For the safety of all occupants, evacuation is recommended if threatening weather occurs, or if there is any doubt concerning the safe use of this product.

4. Proper safety equipment should be used at all times to insure a safe installation and take down. We suggest a careful evaluation be made to determine safety equipment needed, such as hard hats, steel-toe shoes, safety glasses and other as required. It is our desire that all installations are safe. Please be aware of hidden dangers both underground, i.e., gas lines, water lines, electrical lines, etc. and above the tent such as power lines and telephone lines.
5. Anchor stands behind its products in accordance with its standard Terms and Conditions of sale. A copy of our Terms and Conditions of Sale can be obtained by contacting Anchor at the telephone number and/or address on this document.