

Installation Instructions

Century® Mate Expandable

30' & 40' Wide



Please read all of the installation instructions before the installation or removal of this product.



7701 Highway 41 N
Evansville, IN 47725
Phone: 812-867-2421
Fax: 812-867-1429
1-800-544-4445
email: tents@anchorinc.com
www.anchorinc.com

Century® Mate Parts List

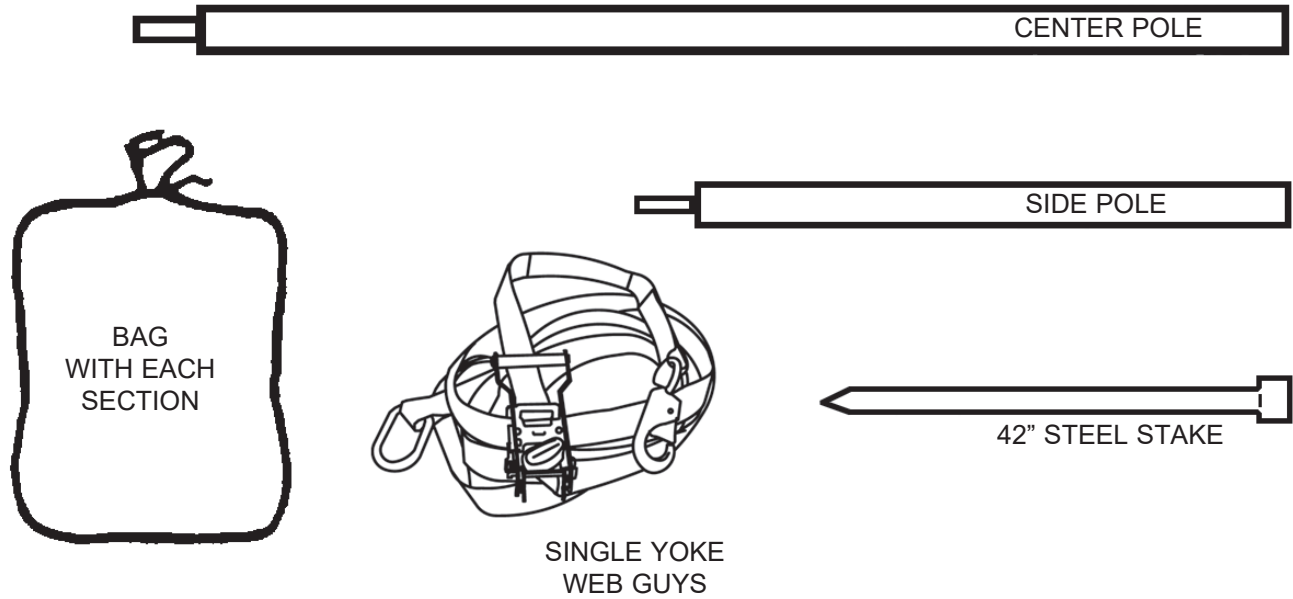

Parts	Ends (Pair - 30' OR 40')	30' x 10' Middle	30' x 15' Middle	30' x 20' Middle	40' x 20' Middle	40' x 30' Middle
CENTER POLE	1	1	1	1	1	1
SIDE POLE	16	2	4	4	4	6
42" STEEL STAKES	20*	2*	4*	4*	4*	6*
SINGLE YOKE WEB GUY	20	2	4	4	4	6
BAGS FOR SECTIONS	2	1	1	1	1	1

* Refer to caution statement #2 for important warning about number of stakes supplied. (See back page)
 The installer must use the local soil conditions to calculate the actual number of stakes required and is responsible for the staking pattern and configuration.

MANPOWER REQUIRED

Two experienced installers should be able to assemble a 30' x 45' tent in approximately one hour.
 Three experienced installers should be able to assemble a 40' x 60' tent in approximately one hour.



INSPECT SITE CAUTION:

Consult local utility company prior to installation.

Prior to assembly be sure to look around area for obstacles, pipes, wires, etc.

TOOLS REQUIRED

Sledge Hammers
 Stake Driver
 2 Measuring Tapes

LAYOUT & CHECK

Use parts list for a quick identification and check list for proper quantities.

1

MEASURE LAYOUT

Measure and mark location of stakes, side poles and center poles.

**To find diagonal measurement: $width^2 + length^2 = diagonal^2$

30' EXPANDABLE

30' X 45' used as an example.

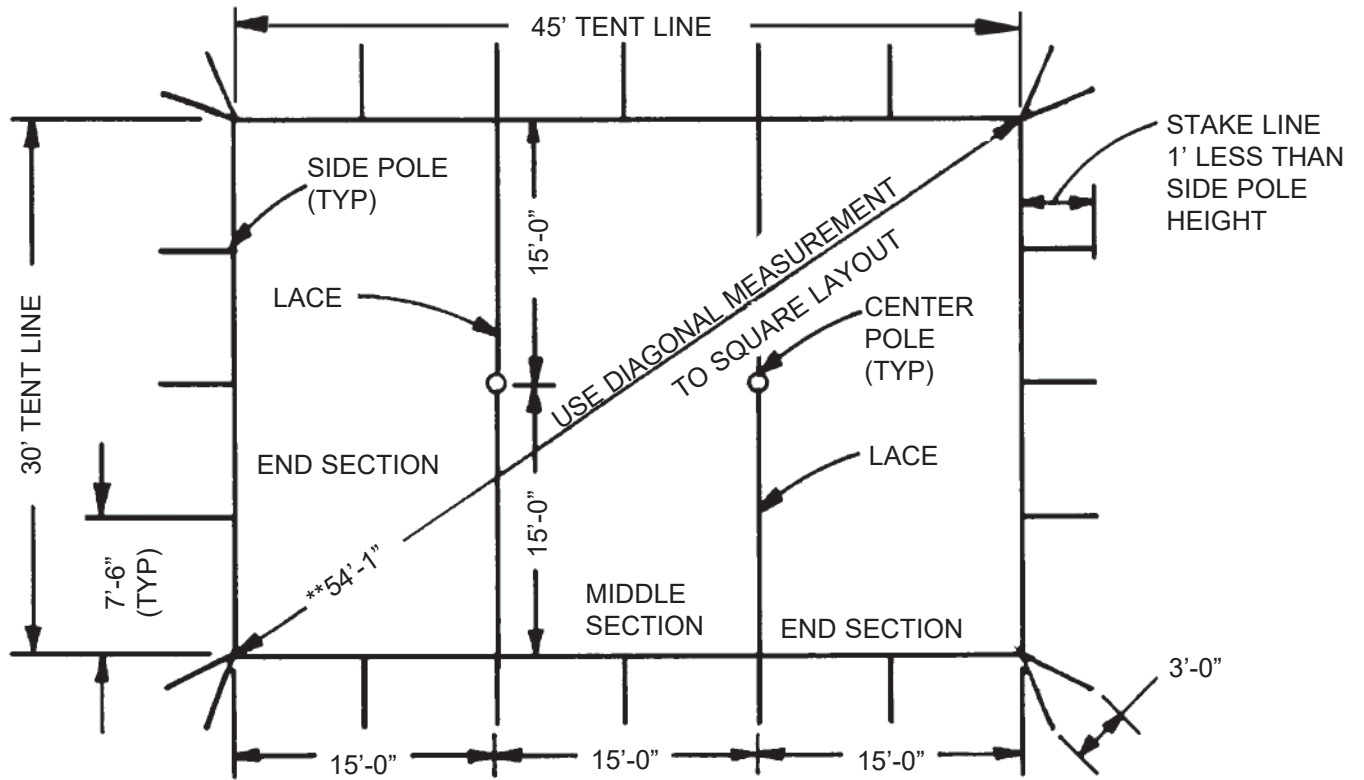

40' EXPANDABLE

40' X 60' used as an example.

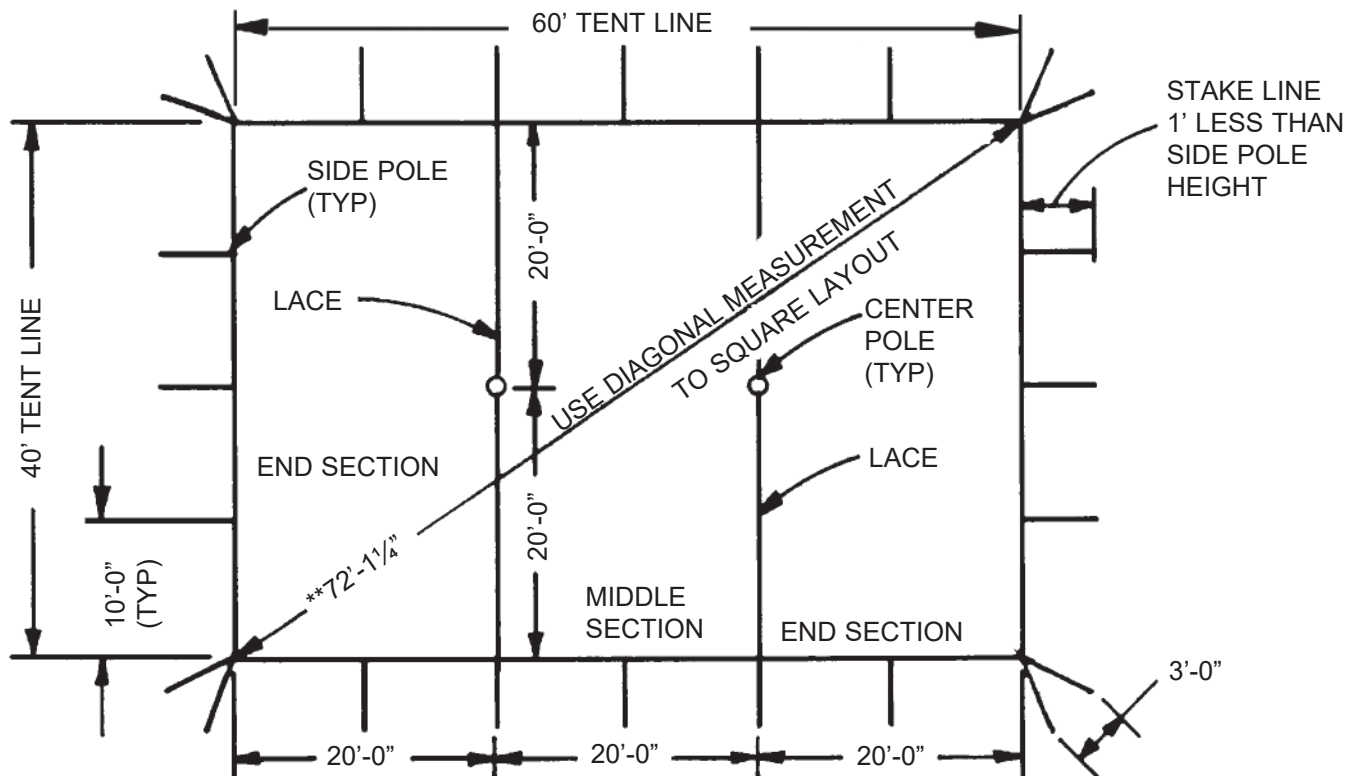

2 LAYOUT AT SITE

Any objects with sharp projections which must remain on site under the tent should be padded and taped.

Spread drop cloths and unroll tent.
Snap web guys to tent top.

3 LACING INSTRUCTIONS

With tent sections on ground, overlap top plates with grommet side on top. Push nipple up through hole in top plates and attach to flange as shown in center pole hole detail. Starting at top, push first loop through corresponding grommet.

Continue lacing process and cover lacing with protective flap and snap to rings or rope as you move down tent section.

Tie off the last long lacing loop.

Attach snap to ring at eave. Repeat lacing steps on opposite side.

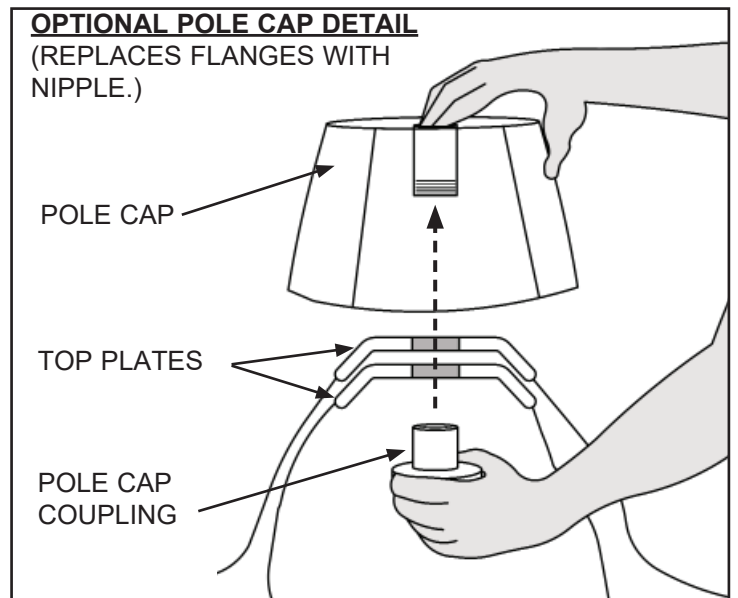
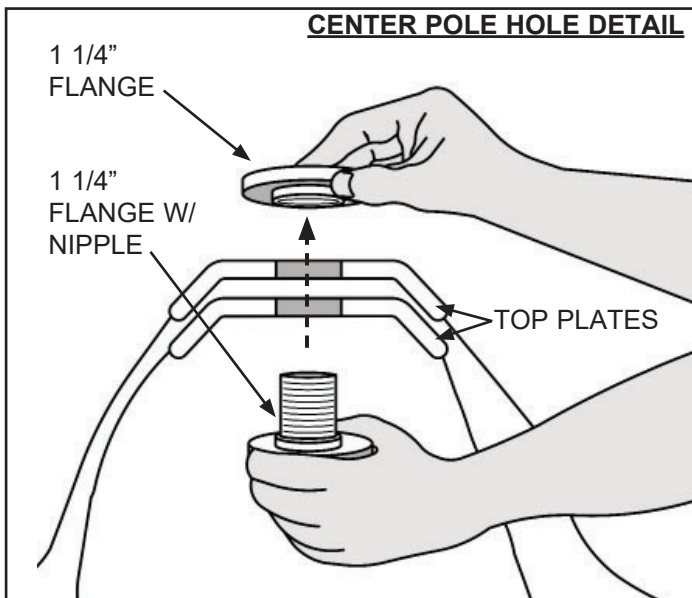
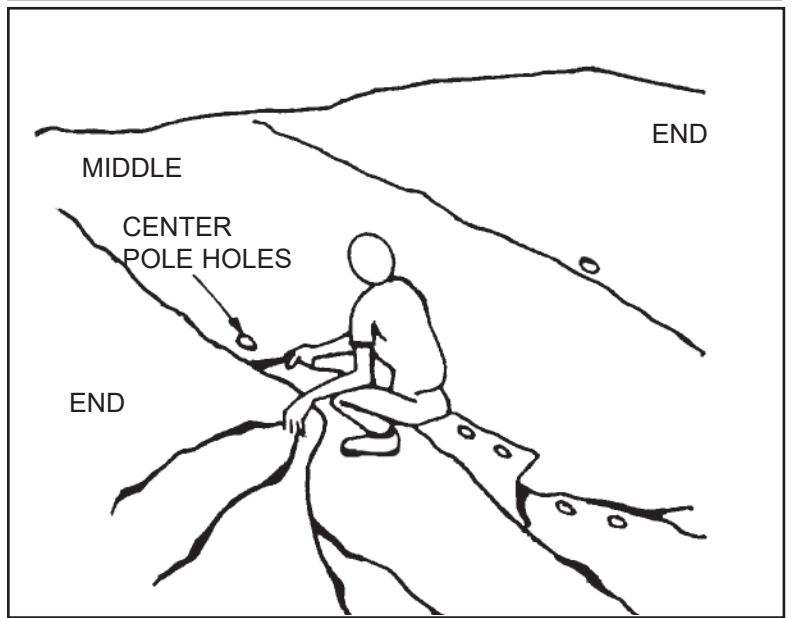
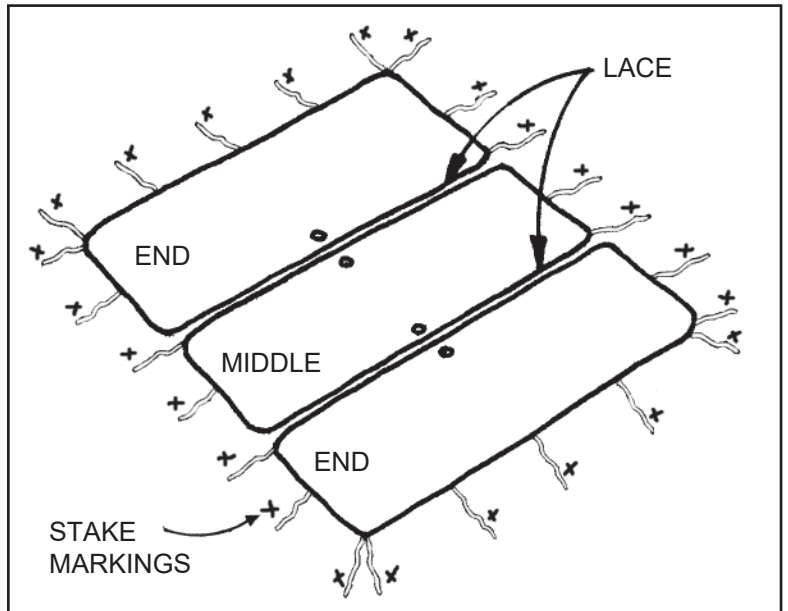
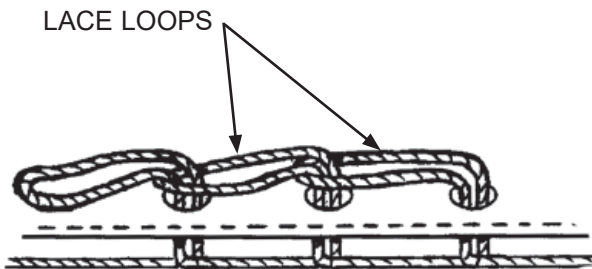

4 TIE DOWN AFTER LACING

After lacing and snapping sections, check guys to be sure they allow plenty of slack for raising tent and enough for ratcheting after tent is properly set up. (approximately 2' of slack)

Run stake through ring on guy web.

Drive stakes at points previously located.

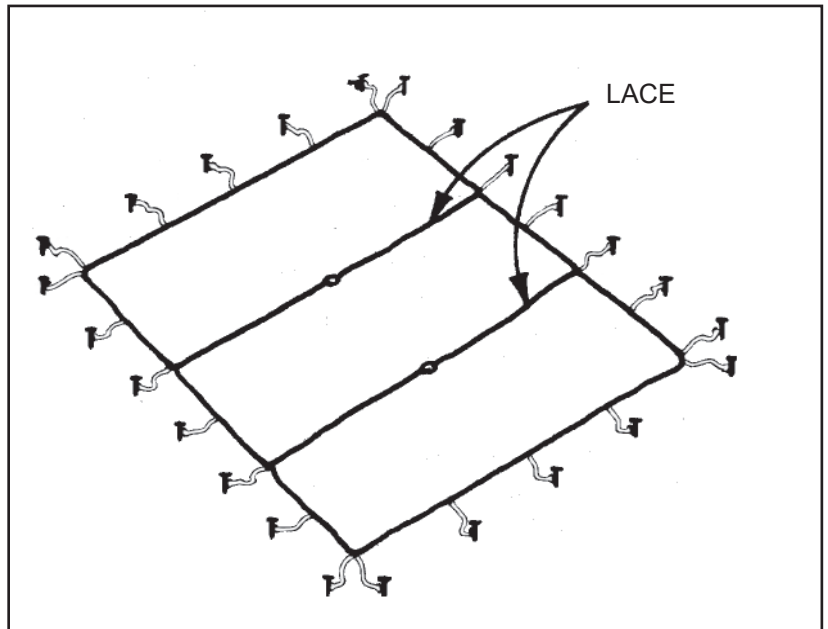
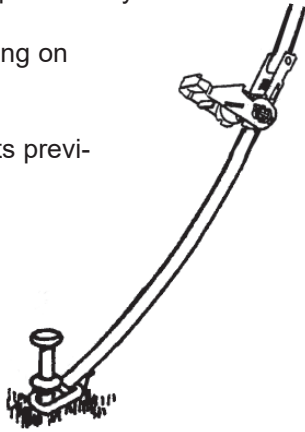

5 RAISE SIDE POLES

Start at side opposite wind. Insert each side pole pin into side pole hole and raise slightly less than perpendicular. Bottom of each pole should be pointed inward toward center of tent.

Tie jump rope around each side pole.

Continue around tent.

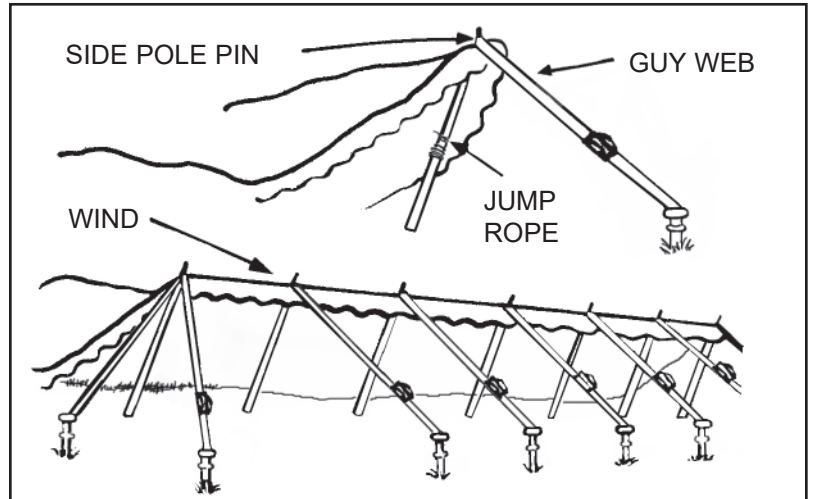

6 RAISE CENTER POLES

One installer to guide center pole pin through hole to prevent snagging or tearing of fabric as pole is being raised to position.

Raise to upright position and tie off jump rope to pole.

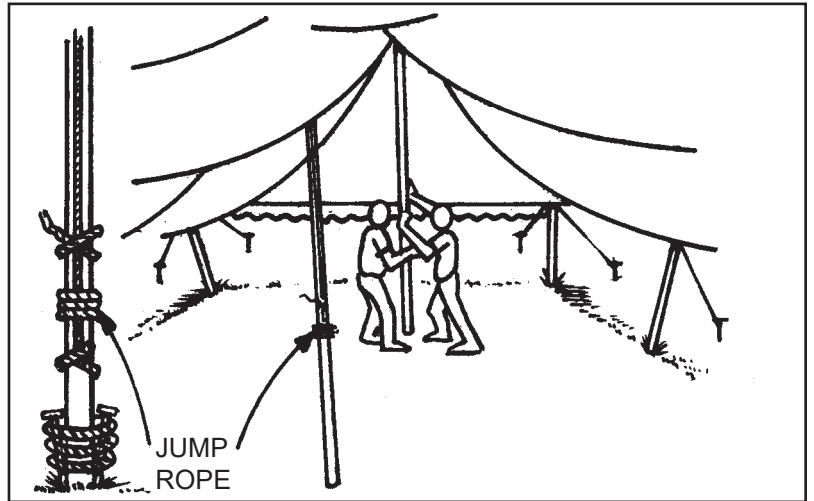

CAUTION:

At this point, properly stake all center poles to prevent movement. Lash pole to two stakes (not provided).

7 SIDE POLE ADJUSTMENT

Tighten guy webs and then set side poles to upright position. Adjust pole positions and guy line tension to properly pull out tent.

Protective covers are recommended for all stakes.

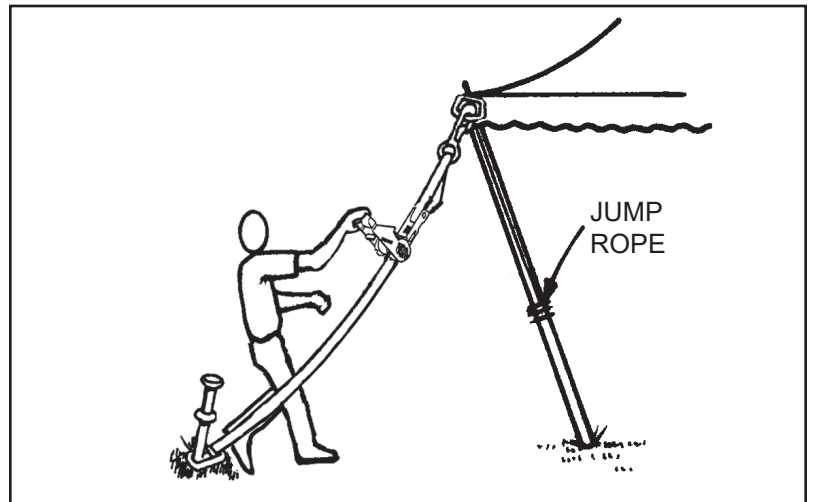

8 TAKE DOWN

1. Spread ground cover.
2. Slant side poles inward.
3. Remove center and side poles.
4. Reverse installation steps.



IMPORTANT:

CHECK WEB GUYS PERIODICALLY FOR TIGHTNESS AND CONDITION.

HOW TO USE THE SMALL GUY WEB, SINGLE WINCH

1. Insert stake into ring end of web. On opposite end, snap onto plate at tent. Leave slack in web for placing poles in position.

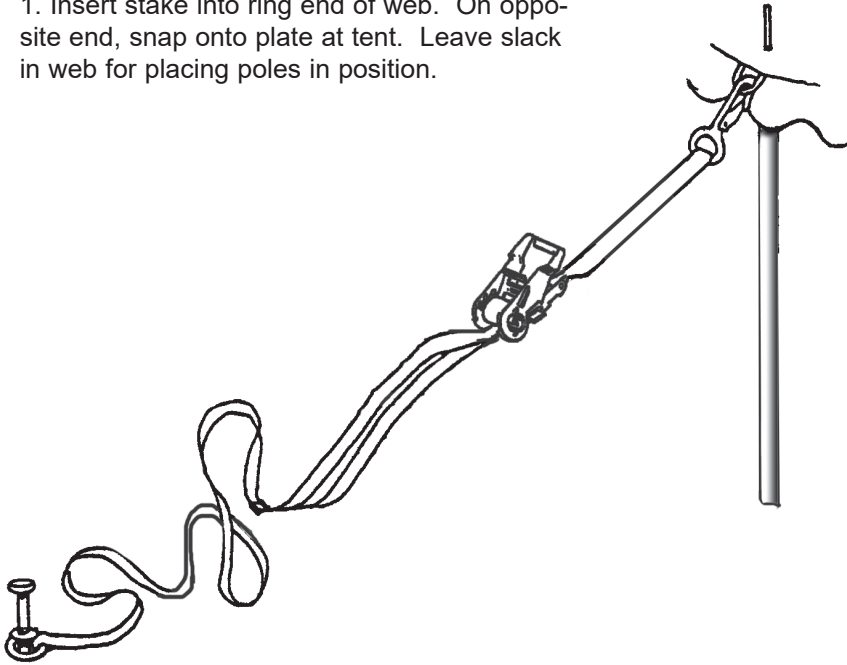

2. Raise poles as directed in product assembly instructions leaving slack in web.

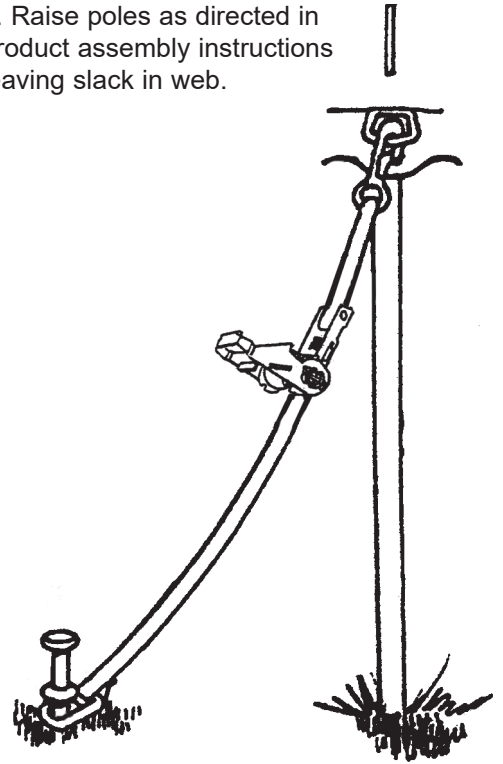

3. When pole is in correct position, release latch and hand pull all slack from web. Then tighten web with winch.

SEE NOTE #1

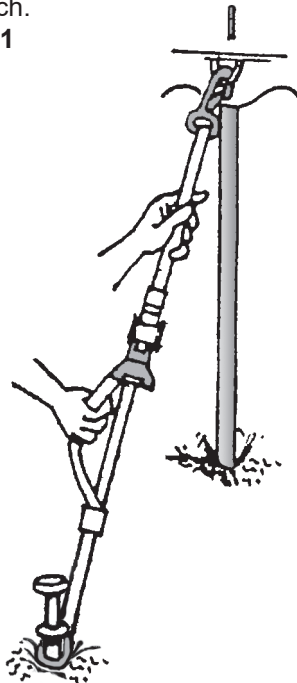

NOTE #1: Do not overfill winch drum. Overfilling winch drum will interfere with release mechanism.

4. When winch is fully opened (handle against web) web can be loosened or tightened as required. To tighten lift latch and move winch handle forward. This motion causes web to wrap around drum. **SEE WARNING**

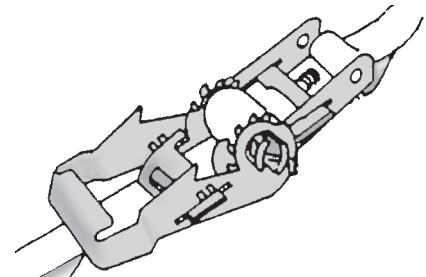

WARNING

WARNING:

1. Use for tensioning tent products only.
2. Do not use if worn web or broken threads.
3. Do not over tension.
4. Follow assembly instructions for safe use.

Anchor products are of superior design and operate best within the parameters of these instructions. It is **IMPERATIVE** that the instructions be carefully read and **COMPLETELY FOLLOWED**.



PHONE NUMBER
812 · 867 · 2421

FAX NUMBER
812 · 867 · 1429

Anchor products are of superior design and operate best within the parameters of these instructions. It is imperative that the instructions be carefully read and **COMPLETELY FOLLOWED**. Please read installation instructions before the installation or removal of this product. Installation instructions are available online at www.anchorinc.com or by calling 1-800-544-4445.



1. For each installation, the installer is solely responsible for evaluating the site and the proper securing method determined. Some soils require different staking or securing than that provided with the tent. Due to this variety of soil conditions, these are the manufacturer's suggested sequence of installation procedures. Anchor's responsibility is limited to the manufacture of the tent parts and materials. We are not responsible for methods that installers may choose to erect and secure the tent to the ground.
2. The number of stakes suggested in the installation instructions do not necessarily meet all or any relevant codes on the site of the tent installation. The number of stakes suggested **will, in many cases, keep the tent erected**, however, due to various soil conditions; these stakes will be insufficient **to keep the tent secure in high winds**. It is the tent installer's responsibility, not the manufacturer, to determine the appropriate number of stakes to meet the necessary wind loads on the site. Regardless of the number of stakes we suggest, we make no representation or warranty as to whether this specific number of stakes will meet the local tent code. Anchor does not, nor can it make any suggestions, representation, or warranties about the adequate staking required at each specific installation site. Staking information provided in the installation instructions **is not a suggestion about what is necessary to meet a site-specific load**.

For additional important information, consult: "The IFAI Procedural Handbook For the Safe Installation and Maintenance of Tentage" and the IFAI Pocket Guide "Pullout Capacity of Tent Stakes", both available from the IFAI Tent Rental Division on their website (www.ifai.com).

3. Inasmuch as the weather is unpredictable, good judgment and common sense must be incorporated within installation guidelines. It is the responsibility of the tent installer/maintainer to determine the severity of the weather, proper time and method of installation and/or erection and disassembly. **Note: We recommend that snow and ice be removed from the tent surface as soon as possible because accumulation will damage the tent or fabric structure. Please consult with our Engineering Department about the maximum loads for each product.**

This product has been manufactured for use as a temporary structure. For the safety of all occupants, evacuation is recommended if threatening weather occurs, or if there is any doubt concerning the safe use of this product.

4. Proper safety equipment should be used at all times to insure a safe installation and take down. We suggest a careful evaluation be made to determine safety equipment needed, such as hard hats, steel-toe shoes, safety glasses and other as required. It is our desire that all installations are safe. Please be aware of hidden dangers both underground, i.e., gas lines, water lines, electrical lines, etc. and above the tent such as power lines and telephone lines.
5. Anchor stands behind its products in accordance with its standard Terms and Conditions of sale. A copy of our Terms and Conditions of Sale can be obtained by contacting Anchor at the telephone number and/or address on this document.