

Installation Instructions

80' Century® Tent

Non-Certified Installation

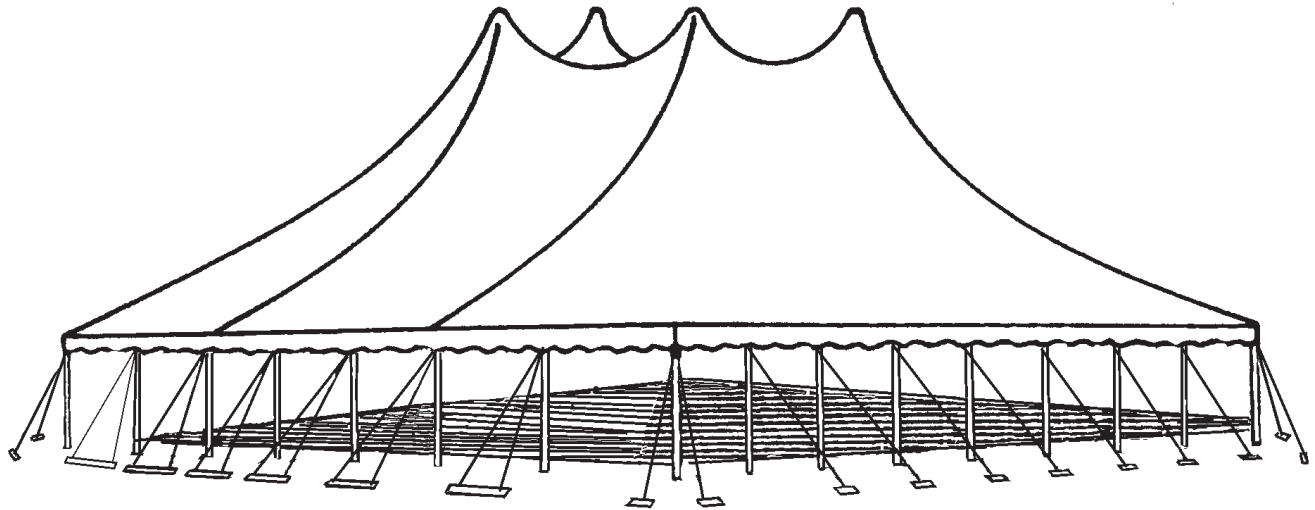

Please read installation instructions before the installation or removal of this product.



7701 Highway 41 N
Evansville, IN 47725
Phone: 812-867-2421
Fax: 812-867-1429
1-800-544-4445
email: tents@anchorinc.com
www.anchorinc.com

Index

Introduction	3
Safety Notes.....	3
Manpower/Tools Required	4
Parts Illustrations	4
Web Guy Layout - Square End Tent and Staking Table	5
Web Guy Layout - Round End Tent	6
Web Guy - Staking Guidelines.....	7
Layout at Site	8
Lacing Instructions	8
Pole Cap	9
Tie down after Lacing	9
Raising Side Poles	9
Raising Center Poles	10
Winch Tensioning.....	10
Final Adjustment and Take Down.....	11

Introduction

The installation of this Century Tent should be performed/supervised by knowledgeable tent installers with a clear understanding of safety issues as well as the methods of anchoring. The requirements as specified with blue print (supplied by Anchor Industries Inc.) must be followed. The installer/owner must read the assembly instructions completely prior to any installation. Particular attention must be given to anchoring! See Caution Statement on back page of this manual

Work from step to step.

Before erecting any tents or membrane structures, first obtain permits and approvals as required from the local building and fire code officials on the jurisdiction of your installation.

PLEASE PAY SPECIAL ATTENTION TO SAFETY WARNINGS AND CAUTIONS FOR PREVENTION OF ACCIDENTS.

Regarding the contents of this document:

The illustrations and photos are made to show clearly the construction and dismantling procedures and also for identification of the components. Not all illustrations/photos correspond to the actual dimensions and size. Explanations and/or notes have been added to these illustrations/photos.

If you have questions, please call your sales representative at the phone number listed on the front of this manual.

Safety Notes

- Please read through this assembly manual completely before beginning your installation. Be sure the proper equipment and safety precautions are in place. We hope that you enjoy the design features of the tent each time the unit is installed.
- Consult your local utility locator service or the National Utility Locating Contractors Association (NULCA) prior to installation.
-
- Prior to actual tent assembly, be sure to look up, down, above & below for obstacles, pipes, wires, trouble, etc.
- Be alert to avoid contact of Tent poles with any overhead power lines near the site.
- Keep site clear of debris to avoid tripping, especially while carrying tent poles or bundle of fabric.
- When moving tent sections by hand, use proper lifting techniques to protect the back.
- The installation method described here requires coordination of tasks between workers. A safe installation is dependent on that coordination. Work cooperatively as a team.
- Replace used or damaged components with original new ones.
- To prevent injuries, wear suitable protective clothing such as hard hats, steel toed shoes, etc.
- Do not drag bundle of fabric on concrete, asphalt, or ground as this can cause damage to the fabric from abrasion through the bag.
- This tent is manufactured for use as a temporary structure. Evacuation is recommended if threatening or windy weather occurs. See caution on back page of this manual.

MANPOWER REQUIRED

Five experienced installers should be able to assemble an 80' x 70' tent in approximately five hours.

TOOLS REQUIRED

- Sledge Hammers
- Stake Driver
- 2 Measuring Tapes

LAYOUT & CHECK

Utilize parts list for a quick I.D. and a check list to ensure that you have all the parts.

Parts Illustrations

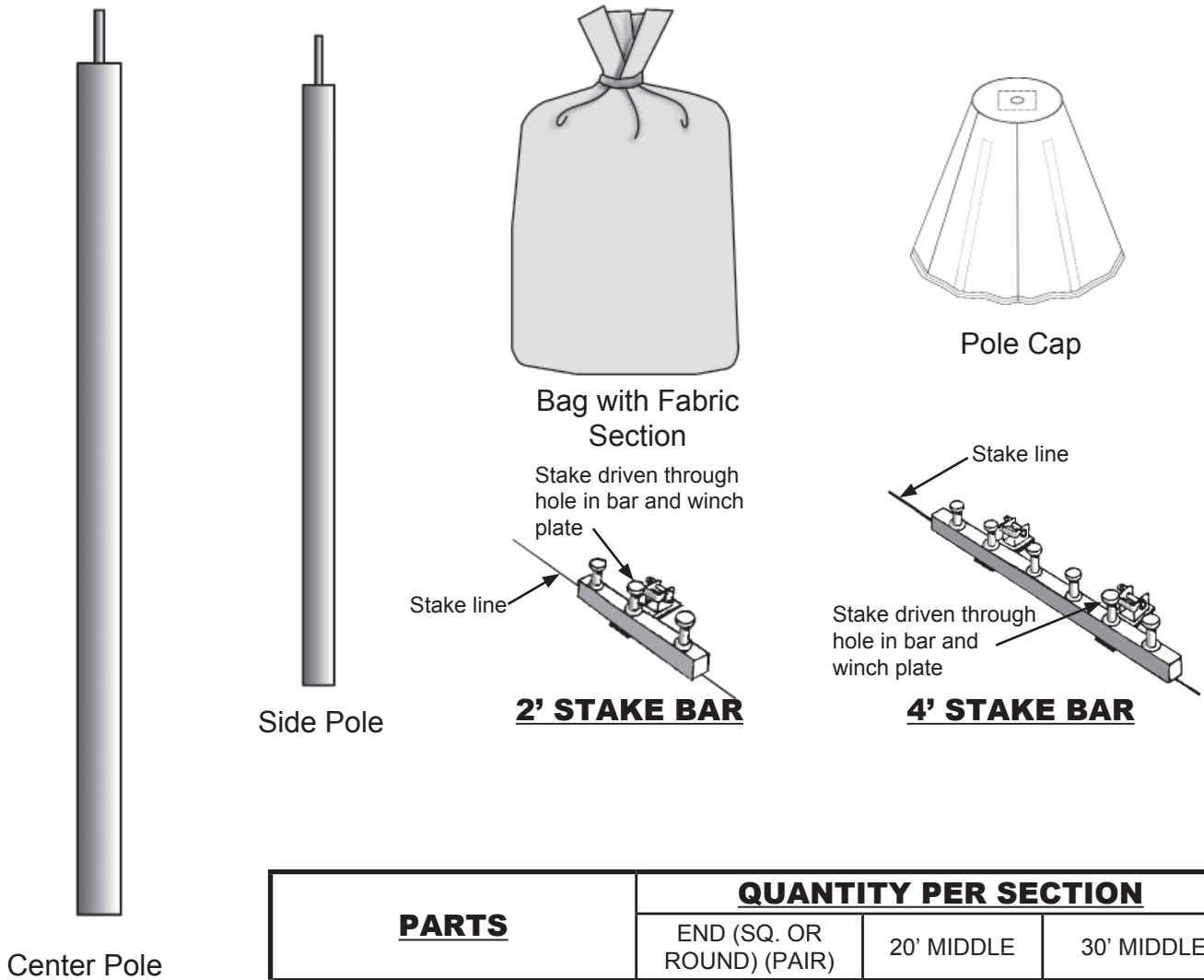

<u>PARTS</u>	<u>QUANTITY PER SECTION</u>		
	END (SQ. OR ROUND) (PAIR)	20' MIDDLE	30' MIDDLE
BAG WITH FABRIC SECTION	2	1	1
CENTER POLE	2	2	2
SIDE POLE	24	4	6
POLE CAP (OPTIONAL)	2	2	2
SEE WEB GUY LAYOUTS & STAKING TABLES FOR STAKING REQUIREMENTS.			

1 WEB GUY LAYOUT*

Square End - Sample Layout

MARK LOCATION OF STAKES, SIDE POLES & CENTER POLES

LAYOUT SHOWS 20' ENDS AND 30' MID.
 30' ENDS AND 20' MIDS USE IDENTICAL
 SPACING AND STAKING. SEE TABLE BELOW.

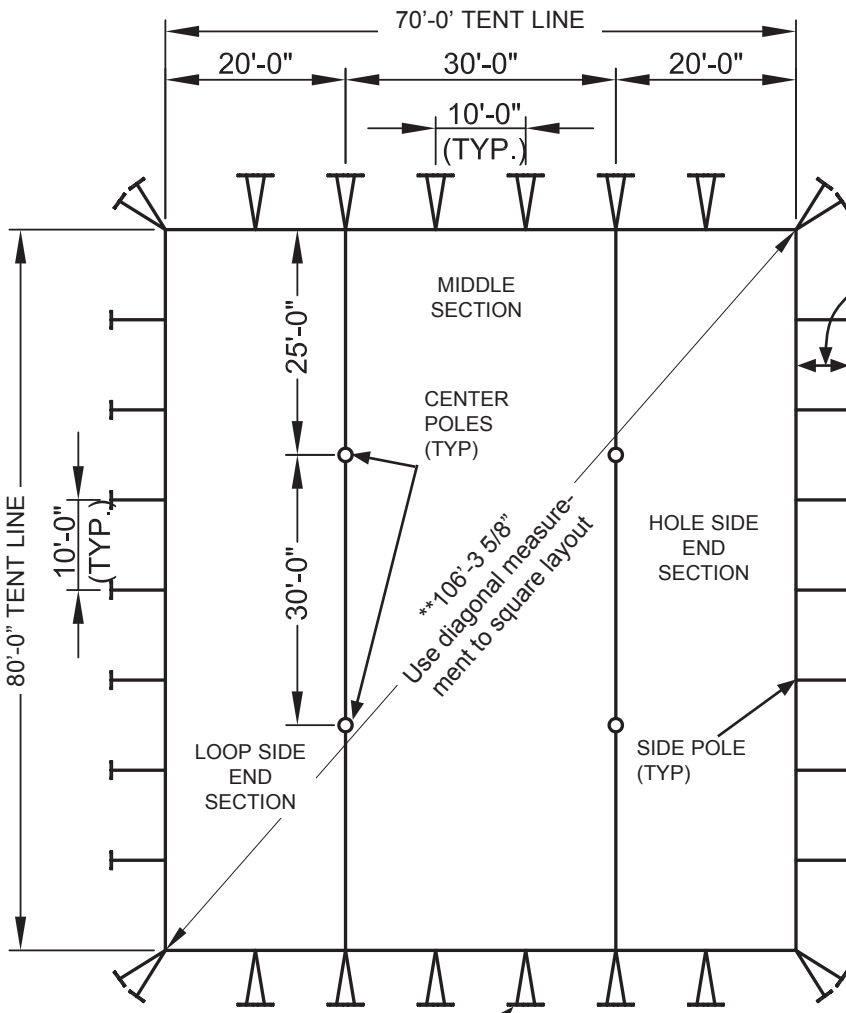

** To find diagonal measurement:
 $diagonal = \sqrt{width^2 + length^2}$

REQUIRED DISTANCE
 BETWEEN SIDE POLES
 AND STAKE LINES:
 7' POLE STAKE OUT 5' 3"
 8' POLE STAKE OUT 6' 0"
 10' POLE STAKE OUT 7' 6"

☉ WEB GUY WITH 2'
 STAKE BAR AND (3) 42"
 STAKES (TYP. AS SHOWN)

★ (2) WEB GUYS WITH (2) 2'
 STAKE BARS AND (6) STAKES
 (TYP. AS SHOWN)

■ (2) WEB GUYS WITH 4'
 STAKE BAR AND (6) 42" DBL.
 HEAD STAKE (TYP. AS SHOWN)

☉ ★ ■ SEE STAKING GUIDELINES ON
 PAGE 7.

Staking Table

Illustration	Item No.	Description	Qty. for 80' x 40' (2) 20' Ends	Qty. for 80' x 40' Round (2) 20' Ends	Qty. for 20' Mid	Qty. for 30' Mid
	23000	Century Guy w/ Winch	34	30	8	12
	37020A 3704242 (over 25)	42" Double Hd. Stake	102*	90*	24*	36*
	33000	2'-0" Stake Bar w/ (3) Holes	22	26	0	0
	33100	4'-0" Stake Bar w/ (6) Holes	6	2	4	6
	23100	Winch Tool	2	2	0	1

Round End - Layout

MARK LOCATION OF STAKES, SIDE POLES & CENTER POLES

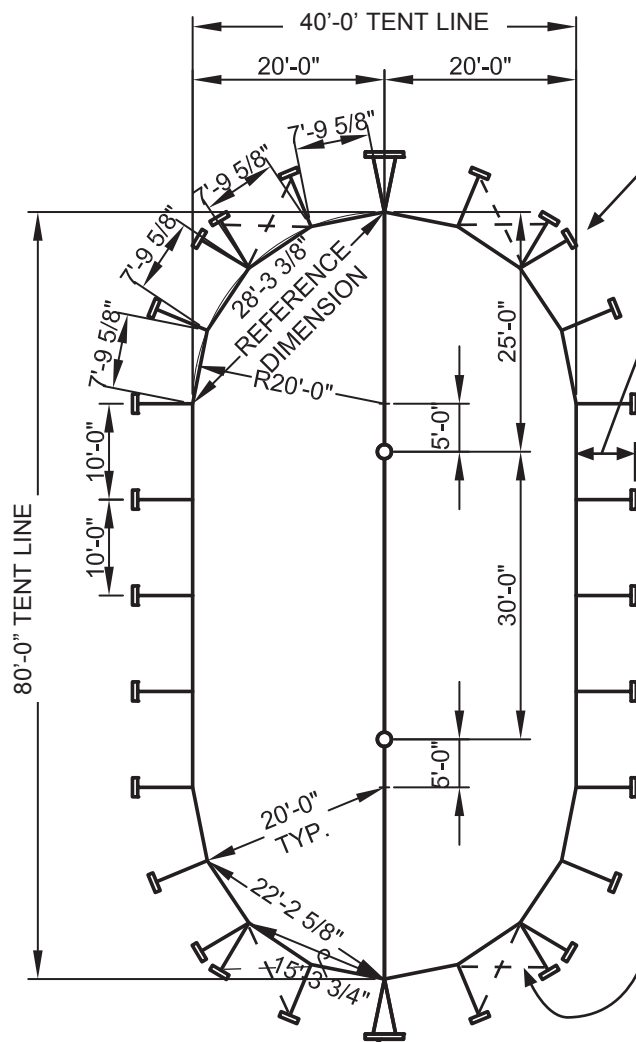

★ (2) WEB GUYS WITH (2) 2' STAKE BARS AND (6) STAKES (TYP. AS SHOWN)

REQUIRED DISTANCE BETWEEN SIDE POLES AND STAKE LINES:
7' POLE STAKE OUT 5'-3"
8' POLE STAKE OUT 6'-0"
10' POLE STAKE OUT 7'-6"

⊙ WEB GUY WITH 2' STAKE BAR AND (3) 42" STAKES (TYP. AS SHOWN)

IMPORTANT NOTE: TO KEEP TOP FROM SPINNING, STAKE THE CORNER GUYS IN THE "X" POSITION SHOWN WITH DASHED LINES UNTIL THE CENTER POLES ARE UP, THEN UNDO THE "X" STAKING AND POSITION THE GUYS AS SHOWN IN SOLID LINES.

■ (2) WEB GUYS WITH 4' STAKE BAR AND (6) 42" DBL. HEAD STAKE (TYP. AS SHOWN)

⊙ ★ ■ SEE STAKING GUIDELINES ON NEXT PAGE.

* **IMPORTANT NOTE:** REFER TO CAUTION STATEMENT #2 FOR IMPORTANT WARNING ABOUT NUMBER OF STAKES SUPPLIED. (SEE BACK PAGE OF THIS MANUAL)

THE INSTALLER MUST USE THE LOCAL SOIL CONDITIONS TO CALCULATE THE ACTUAL NUMBER OF STAKES REQUIRED AND IS RESPONSIBLE FOR THE STAKING PATTERN AND CONFIGURATION. ANCHOR PROVIDES ANCHORING PACKAGES FOR COMMON SOIL CLASSIFICATIONS; CONTACT YOUR TENT SALES REPRESENTATIVE FOR MORE INFORMATION.

WEB GUY - STAKING GUIDELINES

REQUIRED DISTANCE BETWEEN
SIDE POLES AND STAKE LINES:
7' POLE STAKE OUT 5' 3"
8' POLE STAKE OUT 6' 0"
10' POLE STAKE OUT 7' 6"

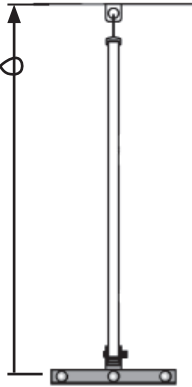

⊙ (1) WEB GUY
WITH 2' STAKE BAR
AND (3) 42" DOUBLE
HEAD STAKES

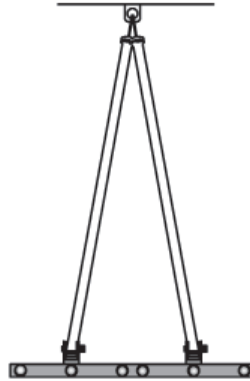

■ (2) WEB GUYS
WITH 4' STAKE BAR
AND (6) 42" DOUBLE
HEAD STAKES



★ (2) WEB GUYS WITH
(2) 2' STAKE BARS
AND (6) STAKES

2 LAYOUT AT SITE

Drive stakes at points located. Each 2' stake bar requires 3 stakes. A 4' stake bar requires 6 stakes.

Spread drop cloths and unroll tent.

Any objects with sharp projections which must remain on site under the tent should be padded and taped.

NOTE: Both Loop side and hole side of sections are required for proper lace.

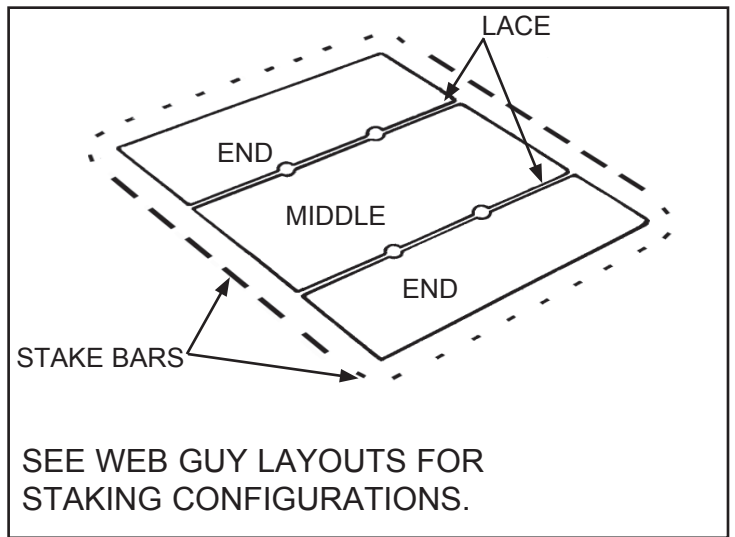

3 LACING INSTRUCTIONS

With tent sections on ground, overlap center pole holes with grommet side on top.

Lace between center pole holes first. Push first loop up through corresponding grommet. Continue, passing each loop through a grommet and the preceding loop.

Continue lacing process and cover lacing with protective double rain flap by velcroing the short flap first, then snapping the top flap to the rope as you move toward the other center pole hole. Tie off last long loop.

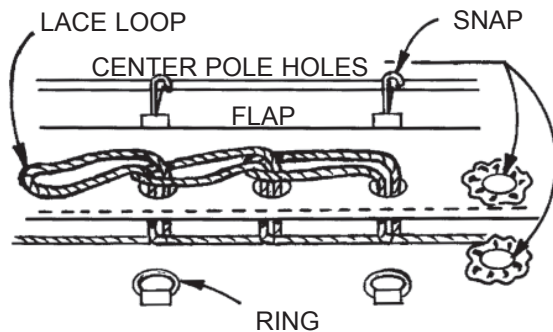
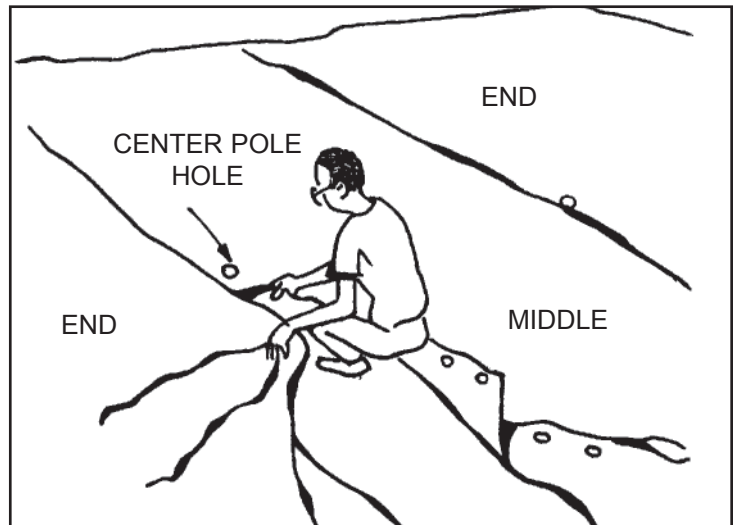

Then lace from center pole to eave on both sides of tent. Tie off last long loop. Align plates and attach hook to plates on inside of tent, as shown.

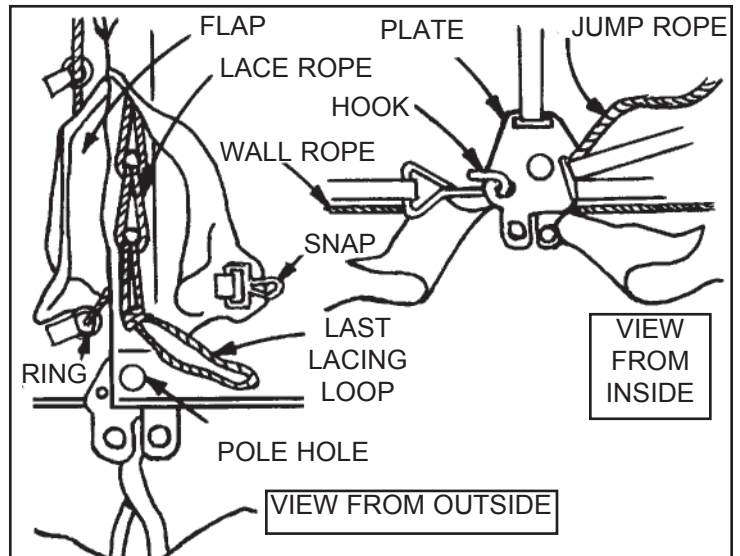

4 POLE CAP

Overlap the pole hole plates in the mid and end fabric lace line. Push fabric and plates up into cap and secure from underneath by threading the female, flanged pipe coupling onto the male pipe fitting molded to the inside top of the pole cap.

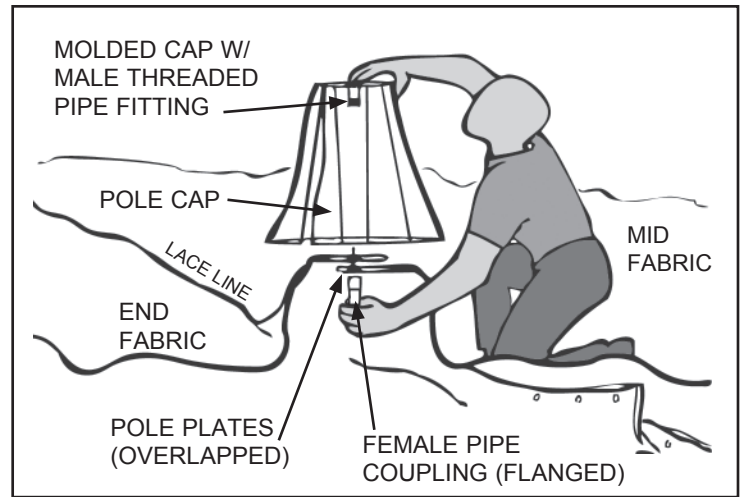

5 TIE DOWN AFTER LACING

After lacing and snapping sections, attach guys and insert loosely into tension winches.

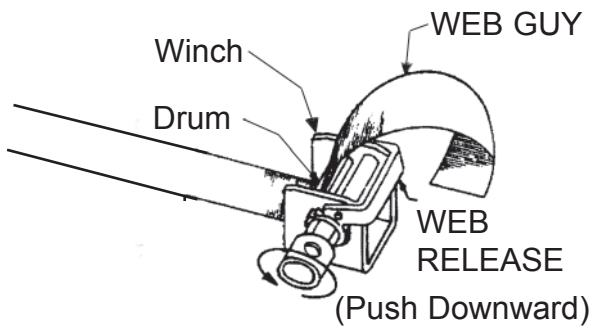

Insert web guy into slot in winch drum and rotate 1 1/2 to 2 times to secure web.

WEBS ATTACHED LOOSELY

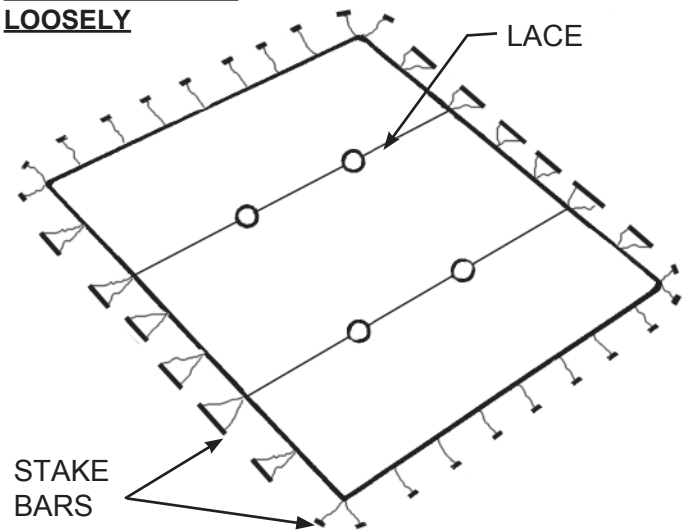

SEE WEB GUY LAYOUTS FOR STAKING CONFIGURATIONS.

6 RAISE SIDE POLES

Start at downwind side. Insert each side pole pin into side pole hole and raise slightly less than perpendicular. Bottom of each pole should be pointed inward toward center of tent.

Wall ropes should run outside of corner poles and side poles.

Tie jump rope around each side pole as it is inserted in pole hole.

Continue around tent.

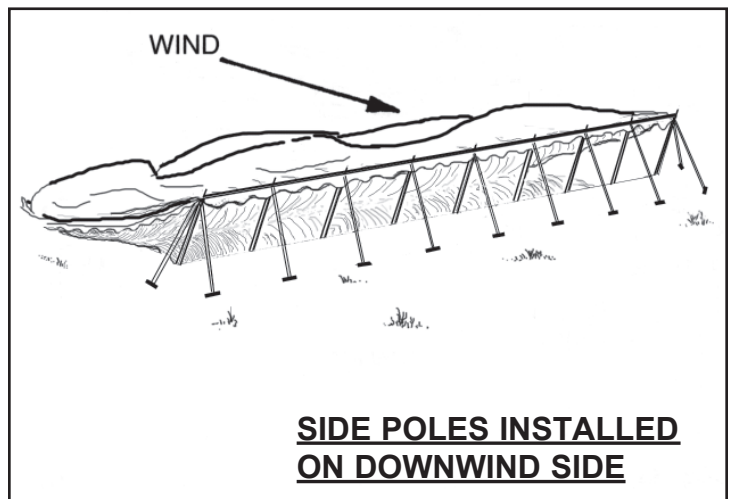

7 RAISE CENTER POLES

JUMP ROPE



Slowly raise center poles nearest to wind direction to approximate position. One installer to guide center pole pin through hole to prevent snagging or tearing of fabric as pole is being raised into position.

Keep pole at a slant until other pole at the same lace is raised. Tie jump ropes as each center pole is placed in approximate position. Adjust bases of poles to exact location and align poles vertically.

CAUTION: At this point, it is required to properly anchor bases of all center poles to prevent movement.

Good Precautionary Measure: It is a good idea to have a spotter on outside of tent to watch that center pole top pin does not get caught on fabric as it is being raised.

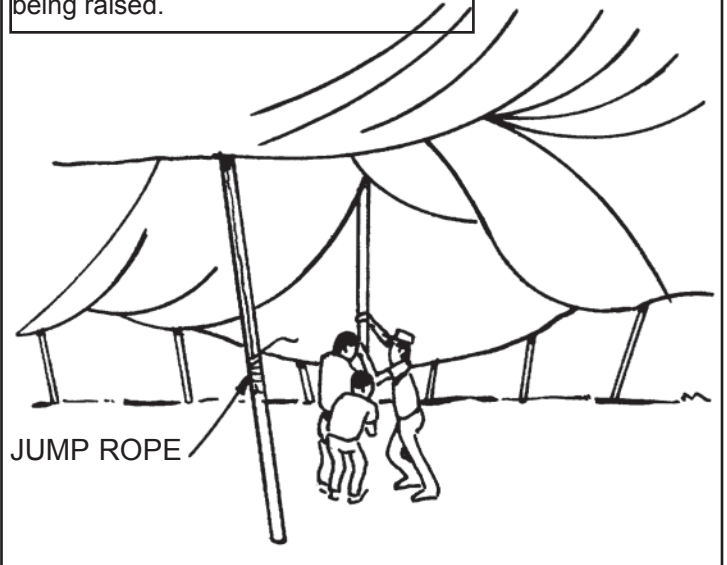

8 WINCH FOR TENSION

If the footprint of the tent has been laid out properly and the tent placed squarely within that footprint, the following **tensioning sequence** is recommended:

1. Tension webs at the lace lines first.
2. Tension webs at the corners.
3. Tension webs at the ends.
4. Tension webs at the middles last.

NOTE: If the tent is not square, or if center poles lean when laces are tensioned, **reverse steps "1" and "2" above.**

At each side pole, release winch tension and place bottom of side pole at the marked footprint eave line location.

Insert web guy into winch. Pull excess through winch. Tension, using winch bar. **DO NOT USE EXTENDERS ON WINCH BAR TOOL.**

Caution -- DO NOT OVER TENSION TENT BEYOND EAVE LINE. DO NOT PULL SIDE POLES OR CENTER POLES BEYOND VERTICAL POSITION.

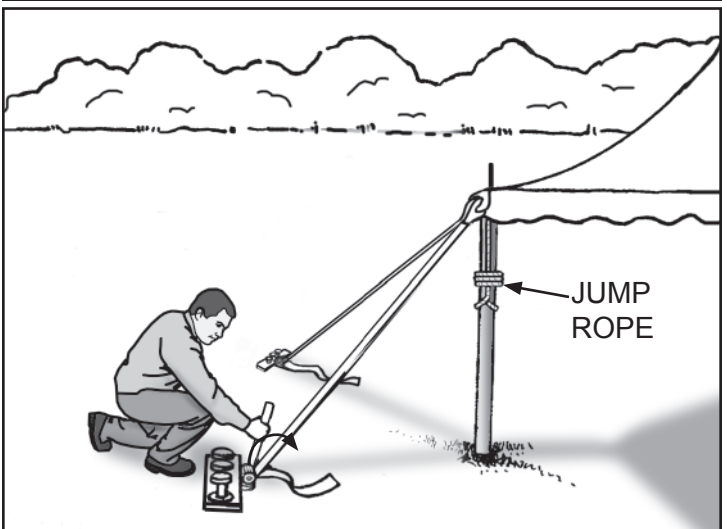
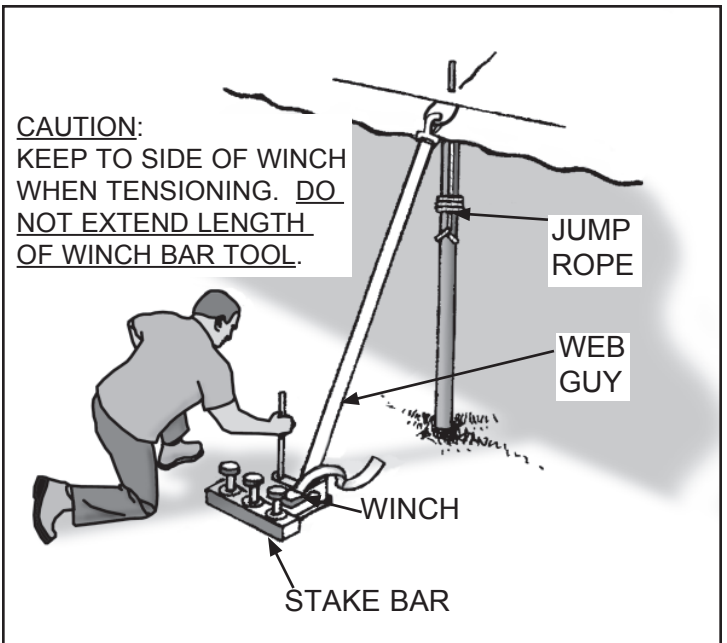

9 FINAL SIDE POLE ADJUSTMENT

With side poles standing vertical and bases at the marked side pole locations for the footprint, ratchet webs to tension the top evenly.

Due to changes in climatic conditions, periodic inspection and adjustment should be made.

Protective covers are recommended for all stakes and stake bars.

10 TAKE DOWN

USE EXTREME CAUTION REMOVING ALL POLES

1. Spread ground cover.
2. Loosen tension on all web winches.
3. Slowly slant side poles inward.
4. Remove center and side poles.
5. Reverse installation steps.

IMPORTANT

Check Guys periodically for tightness and maintenance of good condition. Stakes provided are for average soil conditions. Sandy soil or asphalt may require additional staking. Proper installation suitable to site conditions is the responsibility of the installer. Store tent in a cool, dry area. Never store while wet or damp.



PHONE NUMBER

812 · 867 · 2421

FAX NUMBER

812 · 867 · 0547

Anchor products are of superior design and operate best within the parameters of these instructions. It is imperative that the instructions be carefully read and **COMPLETELY FOLLOWED**. Please read installation instructions before the installation or removal of this product. Installation instructions are available online at www.anchorinc.com or by calling 1-800-544-4445.

CAUTION:

1. For each installation, the installer is solely responsible for evaluating the site and the proper securing method determined. Some soils require different staking or securing than that provided with the tent. Due to this variety of soil conditions, these are the manufacturer's suggested sequence of installation procedures. Anchor's responsibility is limited to the manufacture of the tent parts and materials. We are not responsible for methods that installers may choose to erect and secure the tent to the ground.
2. The number of stakes suggested in the installation instructions do not necessarily meet all or any relevant codes on the site of the tent installation. The number of stakes suggested **will, in many cases, keep the tent erected**, however, due to various soil conditions; these stakes will be insufficient **to keep the tent secure in high winds**. It is the tent installer's responsibility, not the manufacturer, to determine the appropriate number of stakes to meet the necessary wind loads on the site. Regardless of the number of stakes we suggest, we make no representation or warranty as to whether this specific number of stakes will meet the local tent code. Anchor does not, nor can it make any suggestions, representation, or warranties about the adequate staking required at each specific installation site. Staking information provided in the installation instructions **is not a suggestion about what is necessary to meet a site-specific load**.

For additional important information, consult: "The IFAI Procedural Handbook For the Safe Installation and Maintenance of Tentage" and the IFAI Pocket Guide "Pullout Capacity of Tent Stakes", both available from the IFAI Tent Rental Division or on our website.

3. Inasmuch as the weather is unpredictable, good judgment and common sense must be incorporated within installation guidelines. It is the responsibility of the tent installer/maintainer to determine the severity of the weather, proper time and method of installation and/or erection and disassembly. **Note: We recommend that snow and ice be removed from the tent surface as soon as possible because accumulation will damage the tent or fabric structure. Please consult with our Engineering Department about the maximum loads for each product.**

This product has been manufactured for use as a temporary structure. For the safety of all occupants, evacuation is recommended if threatening weather occurs, or if there is any doubt concerning the safe use of this product.

4. Proper safety equipment should be used at all times to insure a safe installation and take down. We suggest a careful evaluation be made to determine safety equipment needed, such as hard hats, steel-toe shoes, safety glasses and other as required. It is our desire that all installations are safe. Please be aware of hidden dangers both underground, i.e., gas lines, water lines, electrical lines, etc. and above the tent such as power lines and telephone lines.
5. Anchor stands behind its products in accordance with its standard Terms and Conditions of sale. A copy of our Terms and Conditions of Sale can be obtained by contacting Anchor at the telephone number and/or address on this document.